

The JBL logo is displayed in a large, bold, black font. The letter 'J' is stylized with a dot and a vertical line extending downwards from its stem. The letters 'B' and 'L' are also bold and blocky.

**STUDIO™ L SERIES**

L226W, L226C, L228C,  
LS326W, LS326C, LS328C

**OWNER'S GUIDE**

# THANK YOU FOR CHOOSING JBL

For more than 60 years, JBL has been involved in every aspect of music and film recording and reproduction, from live performances to the recordings you play in your home, car or office.

We're confident that the JBL speakers you have chosen will provide every note of enjoyment that you expected – and that when you think about purchasing additional audio equipment for your home, car or office, you will once again choose JBL.

Please take a moment to register your product on our Web site at [www.jbl.com](http://www.jbl.com). It enables us to keep you posted on our latest advancements, and helps us to better understand our customers and build products that meet their needs and expectations.

## UNPACKING THE SPEAKERS

Carefully unpack the speakers. If you suspect damage from transit, report it immediately to your dealer and/or delivery service. Keep the shipping carton and packing materials for future use. All models include a mounting template and paint shield.

## PLANNING YOUR SYSTEM

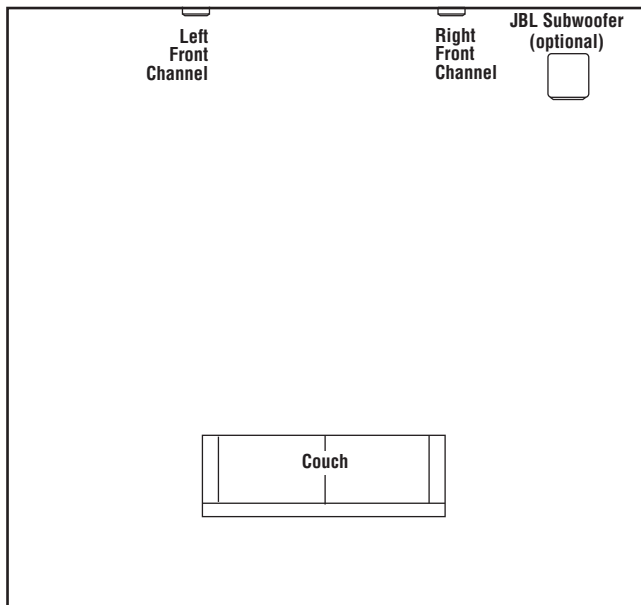

Figure 1.

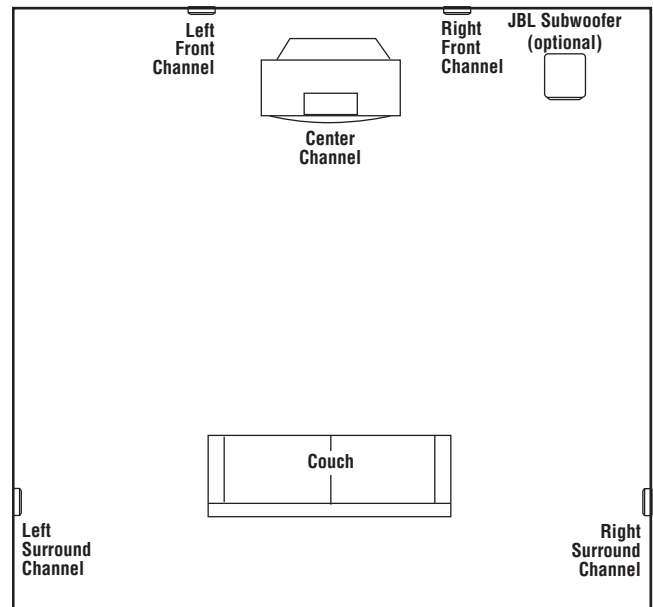

Figure 2. This overhead view shows a typical home theater system arrangement.

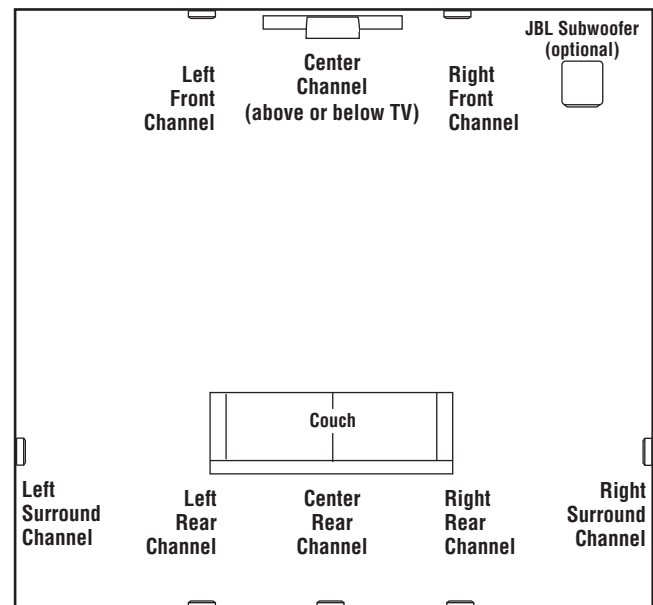

Figure 3. This overhead view shows a 6- or 7-channel home theater system arrangement. Left/right rear channels are for a 7-channel system. Center rear channel is for a 6-channel system.

**NOTE:** Figures 1, 2 and 3 show recommended speaker locations. You may also follow these general placement suggestions when installing the speakers in the ceiling.

## PLACEMENT

### STEREO

Before deciding where to place your speakers, survey your room and think about placement, keeping the following points in mind, and using Figure 1, on previous page, as a guide:

- For best results, place the speakers 6'–8' apart.
- When installing in the wall, position each speaker so that the tweeter is as close to ear level as practical.
- Refer to "Home Theater" below if you also plan to use the speakers in a home theater system.

### HOME THEATER

For front-channel use, place one speaker on the left and another on the right along either side of the television.

A center channel speaker should go directly above or below the television and can be an in-wall, in-ceiling or freestanding center channel.

For left and right surround channels, place one speaker on the left and another on the right, to the side of or slightly behind the listening area. In 6- or 7-channel configurations, place the rear channel(s) behind the listening position, as shown in Figure 3.

**NOTE:** A JBL powered subwoofer will add impact and realism to both music and film soundtracks. Contact your JBL dealer for recommendations on subwoofer models for your application.

Proper placement of the speakers is an important step in obtaining the most realistic soundstage possible. These recommendations are for the optimal placement of the loudspeakers. Use these placement recommendations as a guide. Slight variations will not diminish your listening pleasure.

## INSTALLATION

The Studio™ L Series in-wall and in-ceiling speakers were designed to be easily installed. However, if you are unable to clearly and fully understand and follow the instructions in this manual, or if you are unsure of your ability to properly install these loudspeakers, please contact your dealer or a qualified installer.

### TOOLS NEEDED



Pencil



Phillips #2 screwdriver  
(Do not use a powered screwdriver of any kind)



Measuring tape



Utility knife

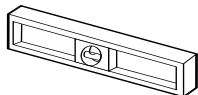

Carpenter's level

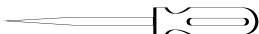

Awl

## SPEAKER CONNECTIONS

### CONNECTION TIPS

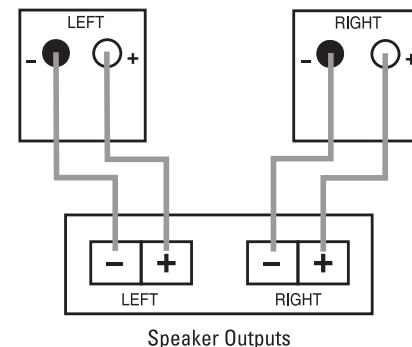
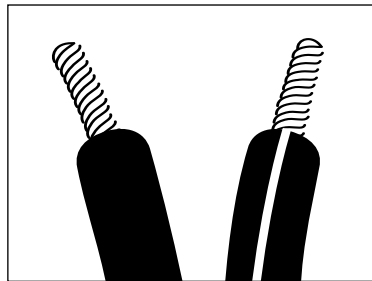

Figure 4.

### Wire Length

Up to 100 ft.  
Greater than 100 ft.

### Recommended Size

16-gauge  
12-gauge

### TURN OFF ALL POWER

Before completing the installation, you must connect your speakers to your system. First, turn off all audio-system power. Use high-quality speaker wire to make your connections. Use at least #16-gauge speaker wire with polarity coding. Heavier gauge wire is recommended for larger distances. Consult the chart above or your dealer for recommendations. The side of the wire with a ridge or other coding is usually considered positive (+) polarity. Also, consult the owner's manuals that were included with your amplifier or receiver to confirm connection procedures.

Observe polarities when making speaker connections, as shown in Figure 4. Connect each + terminal on the back of the amplifier or receiver to the respective + (red) terminal on each speaker. Connect the – (black) terminals in the same way.

### IMPORTANT!

Do not reverse polarities (i.e., + to – , or – to +) when making connections. Doing so will cause poor imaging and diminished bass response. Be certain that positive and negative wire strands are completely isolated to avoid short circuits that may damage your equipment.

# EXISTING CONSTRUCTION

**L226C, L228C, LS326C, LS328C**

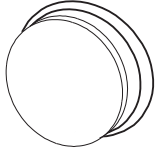

1. Remove the plastic paint shield from the speaker frame.

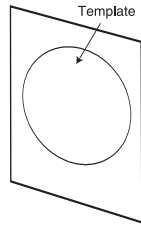

2. Determine the correct speaker location.  
**NOTE:** Use the included template when cutting the drywall.

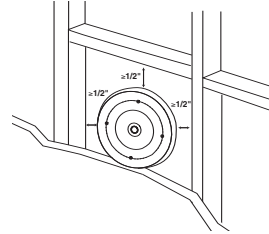

3. **NOTE:** Always allow at least a 1/2 inch between a wall stud and the speaker cutout or the locking tabs will not be able to swivel into place.

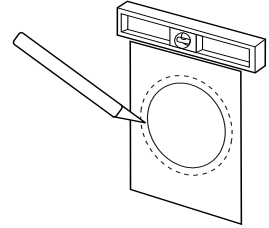

4. Ensure that the drywall or plywood board or other appropriate wallboard is at least 1/2-inch thick and confirm that the board material is capable of withstanding the weight of the speaker you will be installing. Cut the drywall.

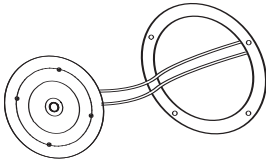

5. Connect the speaker wires to the speaker.

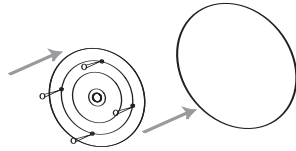

6. Make sure all four locking tabs are properly positioned against the locking tab stops that are located on the speaker frame (see Figure 5 below). After confirming this, carefully place the frame assembly in the wall and confirm that there is no more than 1/8-inch play between the frame and the wall cutout. After positioning the speaker in the mounting location, back each screw out one full turn (turn counterclockwise).

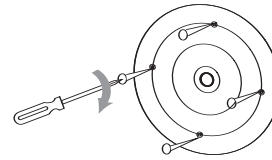

7. Screw down each of the four Phillips-head screws, alternating between the four screws. The locking tabs will swivel into place and secure the unit to the rear surface of the wall panel. Hand-tighten with a nonpowered, straight-handle regular screwdriver only. Do not use a socket wrench, a powered screwdriver, a drill or any other powered tool. Confirm that the speaker is firmly and securely held in place and that all four locking tabs are firmly resting against the wall panel.

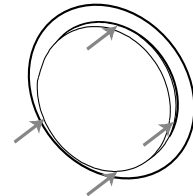

8. Attach the metal grille and logo, if desired.

Figure 5.

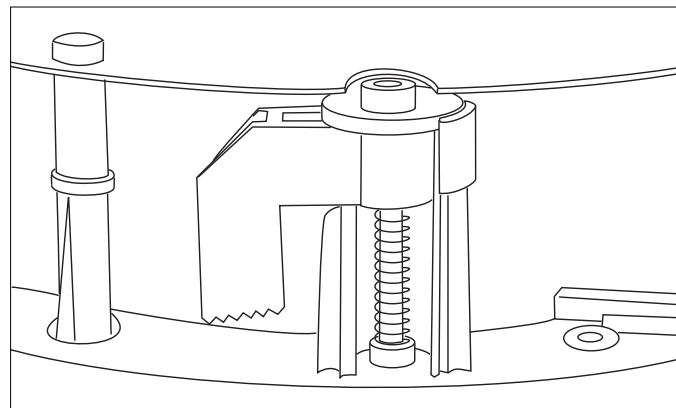

## L226W, LS326W

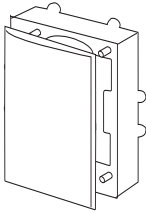

1. Remove the plastic paint shield from the speaker frame.

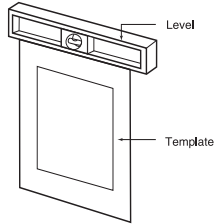

2. Determine the correct speaker location.  
**NOTE:** Use the included template when cutting the drywall.

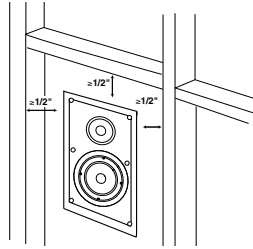

3. **NOTE:** Always allow at least a 1/2 inch between a wall stud and the speaker cutout or the locking tabs will not be able to swivel into place.

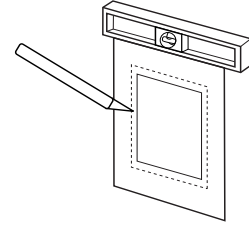

4. Ensure that the drywall or plywood board or other appropriate wallboard is at least 1/2-inch thick and confirm that the board material is capable of withstanding the weight of the speaker you will be installing. Cut the drywall.

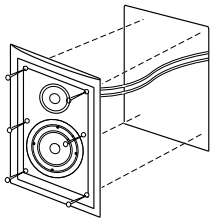

5. Connect the speaker wires to the speaker.

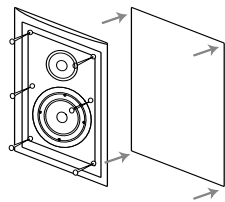

6. Make sure all four locking tabs are properly positioned against the locking tab stops that are located on the speaker frame (see Figure 6 below). After confirming this, carefully place the frame assembly in the wall and confirm that there is no more than 1/8-inch play between the frame and the wall cutout. After positioning the speaker in the mounting location, back each screw out one full turn (turn counterclockwise).

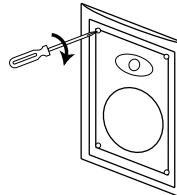

7. Screw down each of the four Phillips-head screws, alternating between the four screws. The locking tabs will swivel into place and secure the unit to the rear surface of the wall panel. Hand-tighten with a nonpowered, straight-handle regular screwdriver only. Do not use a socket wrench, a powered screwdriver, a drill or any other powered tool. Confirm that the speaker is firmly and securely held in place and that all four locking tabs are firmly resting against the wall panel.

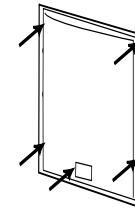

8. Attach the metal grille and logo, if desired.

Figure 6.

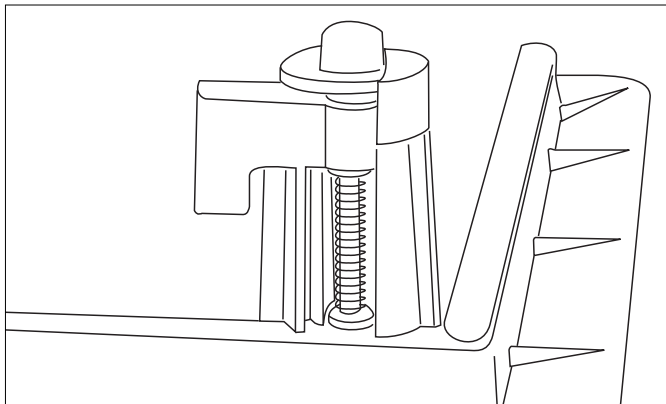

## NEW CONSTRUCTION

If you wish to preinstall a rough-in frame before the drywall is installed, you will need to purchase the correct rough-in-frame kit for your model:

Speaker Model	Rough-In-Frame Kit
L226W, LS326W	RIF 6
L226C, LS326C	RIF 6CS
L228C, LS328C	RIF 8C

Detailed installation instructions are supplied with the rough-in kit.

## PAINTING THE SPEAKER FRAME AND GRILLE

Studio L in-wall and in-ceiling loudspeakers can be painted to match any décor. If you wish to change their color, the satin finish on the grille and frame will function as a primer coat. Before painting, install the paint shield (inner section of template in the assembly kit) securely into the recess in the baffle. This will protect the speaker components and baffle from paint residue. Use a high-quality spray paint, and apply a thin coat of color. **Be certain the grille perforations remain free of paint. Filling them with paint will diminish the sound quality.**

**NOTE:** Gently remove the acoustical foam blanket from the grille before painting. Reattach the blanket after the paint has dried.

## OPERATION

### SURROUND MODES

When using the system in a Dolby® Digital or DTS® home theater system, make sure all speakers are set to “Small.” When using the Studio L in-wall and in-ceiling speakers in a Dolby Pro Logic® home theater system, make sure the receiver’s center channel mode is set to “Normal.”

Some Dolby Digital-equipped receivers/processors offer different setup options for each source or surround mode: e.g., CD-stereo, videotape, Dolby or Pro Logic. In each case, follow your equipment’s instructions to ensure that the subwoofer (if you have one) output is turned on and that the speakers are set to “Small” in each mode.

## SPECIFICATIONS

### Studio L

Frequency Range (-6dB)

Recommended

Amplifier Power Range

Sensitivity

(2.83V @ 1 meter)

Nominal Impedance

Crossover Frequency

Low-Frequency Driver

High-Frequency Driver

External Dimensions

(W x H)

Mounting Cutout Size

(W x H)

Mounting Depth

Weight (Net)

### L226W

30Hz – 20kHz

10 – 125 Watts

89dB

8 Ohms

3,000Hz;  
24dB/Octave

6-1/2" (165mm)  
Aluminum cone

1" (25mm)  
Titanium-laminate

8-1/2" x 11"  
(216mm x 280mm)

7" x 9-1/2"  
(178mm x 241mm)

3-9/16" (90mm)

3.5 lb (1.6kg)

### L226C

30Hz – 20kHz

10 – 125 Watts

89dB

8 Ohms

2,500Hz;  
18dB/Octave

6-1/2" (165mm)  
Aluminum cone

1" (25mm)  
Titanium-laminate

Diameter: 9-3/16"  
(233mm)

Diameter: 7-7/8"  
(200mm)

4-1/8" (104mm)

3.5 lb (1.6kg)

### L228C

28Hz – 20kHz

10 – 135 Watts

90dB

8 Ohms

2,500Hz;  
18dB/Octave

8" (200mm)  
Aluminum cone

1" (25mm)  
Titanium-laminate

Diameter: 10-7/8"  
(276mm)

Diameter: 9-1/2"  
(241mm)

4-5/8" (117mm)

5.8 lb (2.6kg)

### Studio L

Frequency Range (-6dB)

Recommended

Amplifier Power Range

Sensitivity

(2.83V @ 1 meter)

Nominal Impedance

Crossover Frequency

Low-Frequency Driver

High-Frequency Driver

External Dimensions

(W x H)

Mounting Cutout Size

(W x H)

Mounting Depth

Weight (Net)

### LS326W

30Hz – 30kHz

10 – 135 Watts

89dB

8 Ohms

3,000Hz;  
24dB/Octave

6-1/2" (165mm)  
Aluminum cone

1" (25mm)  
Titanium

8-1/2" x 11"  
(216mm x 280mm)

7" x 9-1/2"  
(178mm x 241mm)

3-9/16" (90mm)

3.5 lb (1.6kg)

### LS326C

30Hz – 30kHz

10 – 135 Watts

89dB

8 Ohms/channel

2,500Hz;  
18dB/Octave

6-1/2" (165mm)  
Aluminum cone

1" (25mm)  
Titanium

Diameter: 9-3/16"  
(233mm)

Diameter: 7-7/8"  
(200mm)

4-1/8" (104mm)

3.5 lb (1.6kg)

### LS328C

28Hz – 30kHz

10 – 150 Watts

90dB

8 Ohms

2,500Hz;  
18dB/Octave

8" (200mm)  
Aluminum cone

1" (25mm)  
Titanium

Diameter: 10-7/8"  
(276mm)

Diameter: 9-1/2"  
(241mm)

4-5/8" (117mm)

5.8 lb (2.6kg)

All features and specifications are subject to change without notice.

Declaration of Conformity



We, Harman Consumer Group International  
2, route de Tours  
72500 Château du Loir  
France

declare in own responsibility that the products described in this  
owner's manual are in compliance with technical standards:

EN 61000-6-3:2001  
EN 61000-6-1:2001

Laurent Rault  
Harman Consumer Group International  
Château du Loir, France 9/06

JBL is a trademark of Harman International Industries, Incorporated, registered in the United States and/or other countries. Pro Sound Comes Home and Studio Series are trademarks of Harman International Industries, Incorporated.

Dolby and Pro Logic are registered trademarks of Dolby Laboratories.

DTS is a registered trademark of DTS, Inc.

**JBL**

**PRO SOUND COMES HOME™**

Harman Consumer Group, Inc., 250 Crossways Park Drive, Woodbury, NY 11797 USA  
8500 Balboa Boulevard, Northridge, CA 91329 USA  
516.255.4JBL (4525) (USA only) [www.jbl.com](http://www.jbl.com)  
© 2006 Harman International Industries, Incorporated. All rights reserved.  
Part No. 406-000-05529-E

**H** A Harman International Company